

21" width

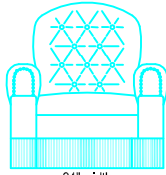

24" width

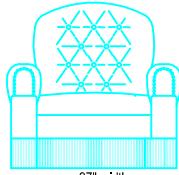

27" width

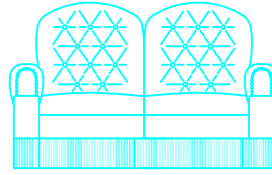

Dual 24" connected seats for 48" loveseat

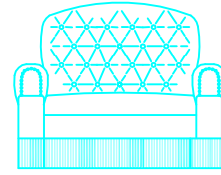

36" SINGLE LOVESEAT-pwr only

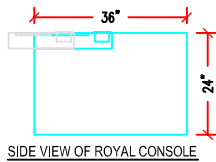
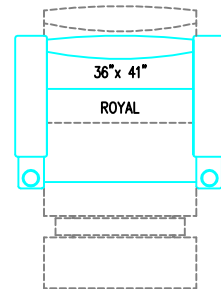
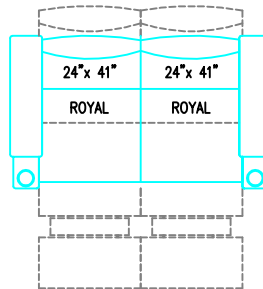
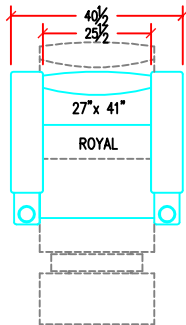
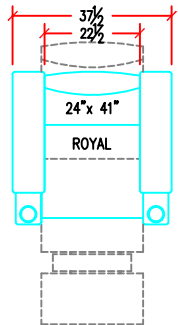
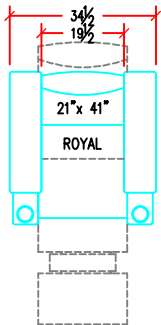

SIDE VIEW OF ROYAL CONSOLE

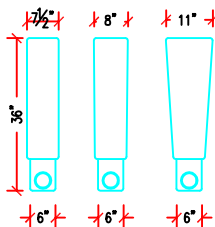

STRAIGHT & WEDGE ARMS

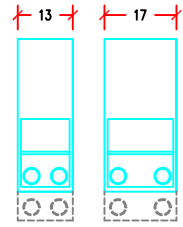

TOP VIEW OF ROYAL CONSOLE

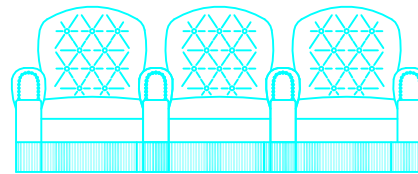

Row of 3- 24" width

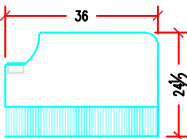

SIDE VIEW OF ROYAL ARM W/FRINGER

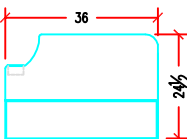

SIDE VIEW OF ROYAL ARM

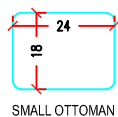

SMALL OTTOMAN



SHARK REMOVABLE ARM

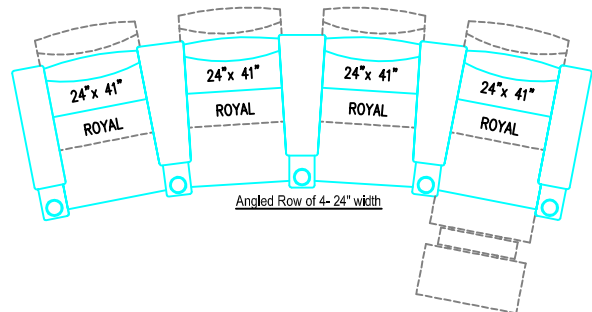

Angled Row of 4- 24" width

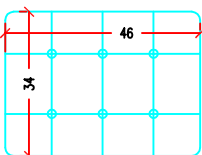

LARGE OTTOMAN (OPTIONAL PULLOUT BED)

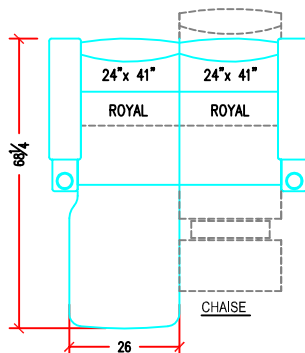

CHAISE

We recommend that the Minimum distance between rows is 84" from back of chair to back of chair

Average Weight
Chair: 100 lbs
Arm: 25 lbs
Console: 35 lbs

ALL MEASUREMENTS ARE APPROXIMATE AND SUBJECT TO CHANGE WITHOUT NOTICE. DUPLICATION IN WHOLE OR IN PART WITHOUT WRITTEN CONSENT IS PROHIBITED. COPYRIGHT 1998-2011 ACOUSTIC INNOVATIONS INC.

CINEMACHAIR LAYOUT

ROYAL

ACOUSTIC INNOVATIONS

ALL MEASUREMENTS ARE APPROXIMATE AND SUBJECT TO CHANGE WITHOUT NOTICE. DUPLICATION IN WHOLE OR IN PART WITHOUT WRITTEN CONSENT IS PROHIBITED.
© COPYRIGHT 2007 ACOUSTIC INNOVATIONS INC